











参数调节说明:

1. 在开机状态下长按“”键3秒关机.
在关机状态下长按“”键1秒开机.
2. 在开机状态下同时按“”键和“”键3秒显示窗显示“TP2”加热温度(正常显示饮用温度).
3. 在关机状态下同时按“”键和“”键5秒,显示代码,按“”键代码切换,按“”键和“”键参数调节.

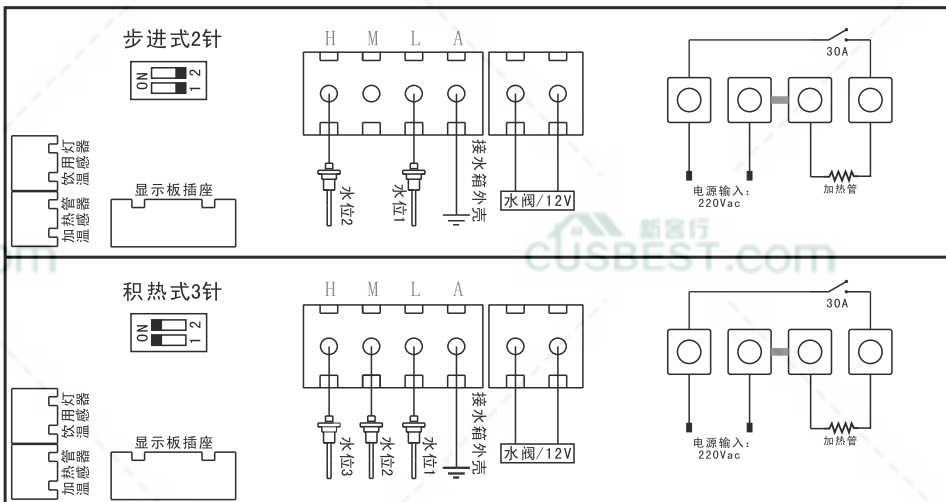

故障代码说明

HH1	饮用温感器开路
LL1	饮用温感器短路
HH2	加热温感器开路
LL2	加热温感器短路
Er1	进水故障(进水超50分钟)
Er2	加热故障(加热35分钟温度低于60度)
ELL	水箱缺水

参数代码说明

HP	加热温度(50-99度)
HY	回差温度(1-30度)
Ad	校正温度(±10度)(只校正饮用温度)
Ho	加热管在水箱水未满时执行的加热温度,也是进水温度.(50-100度)(步进式有效)